



# Panasonic®

## Quick Reference Guide



IP Proprietary Telephone

Model No. **KX-NT321**

Thank you for purchasing an IP Proprietary Telephone (IP-PT). Please read this manual carefully before using this product and save this manual for future use.

For more details, please refer to the manuals of the PBX.

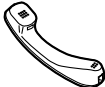
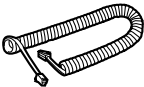
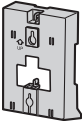
### Accessories (included)

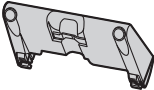
|  |   |  |
|--|---|--|
| <input type="checkbox"/> Handset<br><br>One | <input type="checkbox"/> Handset Cord<br><br>One | <input type="checkbox"/> Wall Mounting Adaptor<br><br>One |
| <input type="checkbox"/> Screws<br><br>Two | <input type="checkbox"/> Stand<br><br>One       |  |

### This model supports the following PBX versions and CODEC types:

KX-TDA50: PSMPR Software File Version 4.0000 or later

KX-TDA100/KX-TDA200: PMPR Software File Version 5.0000 or later

KX-TDA600: PLMPR Software File Version 5.0000 or later

KX-TDE100/KX-TDE200: PMMPR Software File Version 1.0000 or later

CODEC: G.729A, G.711, G.722 \*<sup>1</sup>

\*<sup>1</sup> G.722 is only available for KX-TDE100/KX-TDE200.

# Location of Controls

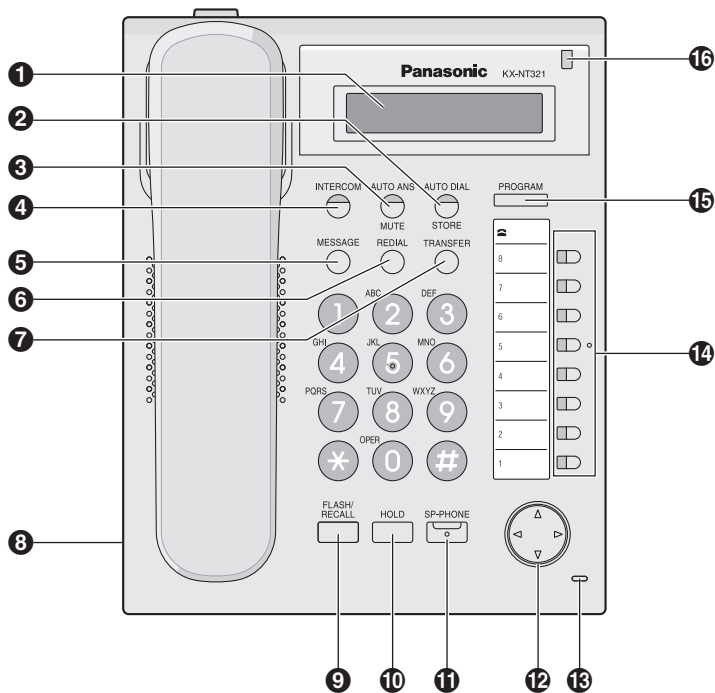

- 1 LCD (Liquid Crystal Display)**
- 2 AUTO DIAL/STORE:** Used for System/Personal Speed Dialing or storing program changes.
- 3 AUTO ANS (Auto Answer)/ MUTE:** Used to receive an incoming call in hands-free mode or mute the microphone/handset during a conversation.
- 4 INTERCOM:** Used to make or receive intercom calls.
- 5 MESSAGE:** Used to leave a message waiting indication or call back the party who left the message waiting indication.
- 6 REDIAL:** Used to redial the last dialed number.
- 7 TRANSFER:** Used to transfer a call to another party.
- 8 Headset Jack**
- 9 FLASH/RECALL:** Used to disconnect the current call and make another call without hanging up.
- 10 HOLD:** Used to place a call on hold.
- 11 SP-PHONE (Speakerphone):** Used for performing hands-free operations.
- 12 Navigator Key:** Used to adjust the volume and the display contrast or select desired items.
- 13 Microphone:** Used for hands-free conversations.
- 14 Flexible CO Buttons:** Used to seize a CO line or perform a feature that has been assigned to the key.
- 15 PROGRAM:** Used to enter and exit the personal programming mode.
- 16 Message/Ringer Lamp:** When you receive an intercom call, the lamp flashes green, and on an outside call, the lamp flashes red. When someone has left you a message, the lamp stays on red.

# Settings

|  |   |   |
|--|---|---|
| <b>Speaker volume</b>                      | <i>While in a hands-free conversation</i> |  |
| <b>Handset/Headset volume<sup>*1</sup></b> | <i>While using the handset or headset</i> |   |
| <b>Ringer volume</b>                       | <i>While on-hook or receiving a call</i>  |   |

Press **Up** to increase or **Down** to decrease the volume.

## LCD Contrast

*While on-hook*



## Ring Tone

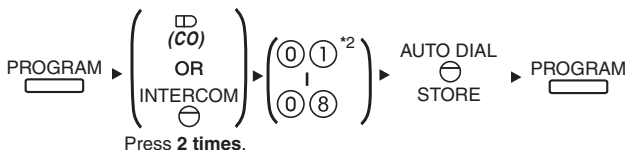

## LCD Backlight



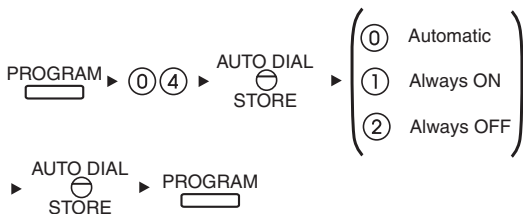

*While on-hook*



















<sup>\*1</sup> If you hear your own voice through the handset or headset, decrease the volume.

<sup>\*2</sup> The ring tone pattern of patterns 09 to 30 is the same as pattern 01.

## Icon Meanings

 = Flexible CO button   
  = Off-hook   
  = On-hook  
 = Feature number   
  = Talk   
 C.  Tone = Confirmation Tone

## Making Calls

| Calling   |  |
|---|--|
| <b>To an extension</b><br> ▶ extension no. ▶    | <b>To an outside party</b><br> ▶  (CO) ▶ outside phone no. ▶  |
| Redial  |  |
|  ▶ REDIAL  ▶   |  |
| Quick Dialing   |  |
|  ▶ quick dial no. ▶   |  |
| One-touch Dialing   |  |
| <b>To store</b><br>PROGRAM  (CO) ▶ ② ▶ desired no.* (max. 32 digits) ▶ AUTO DIAL  STORE ▶ PROGRAM  |  |
| * Enter CO line access number before outside phone number.  |  |
| <b>To dial</b><br> ▶  (One-touch Dialing) assigned as a One-touch Dialing button ▶                |  |

# Features List

## Personal Speed Dialing

### To store



\* Enter CO line access number before outside phone number.

### To dial



## System Speed Dialing

### To dial



## Doorphone Call

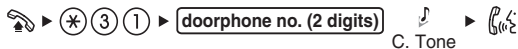

## During a Conversation

### Call Hold

#### To hold



#### To retrieve a call at the holding extension



#### To retrieve an outside call from another extension



## Call Transfer

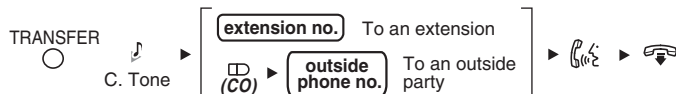

## Useful Features

### Multiple Party Conversation

#### To add other parties during a conversation (i.e., conference)

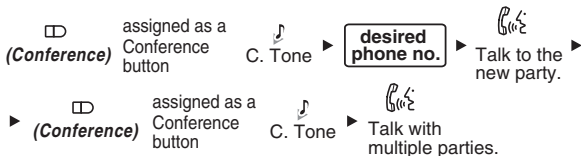

#### To leave a conference

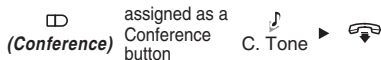

## Setting the Telephone According to Your Needs

### Do Not Disturb

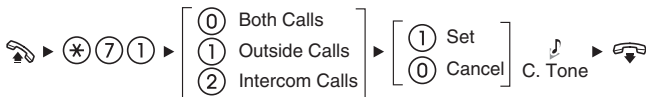

### Timed Reminder

#### To set

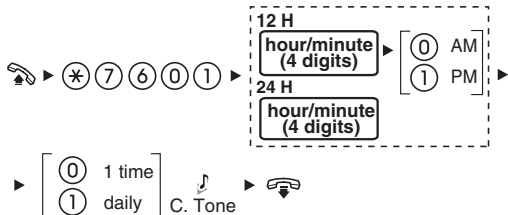

#### To cancel



#### To stop or answer the ring back



# Features List

## Before Leaving Your Desk

### Call Forwarding

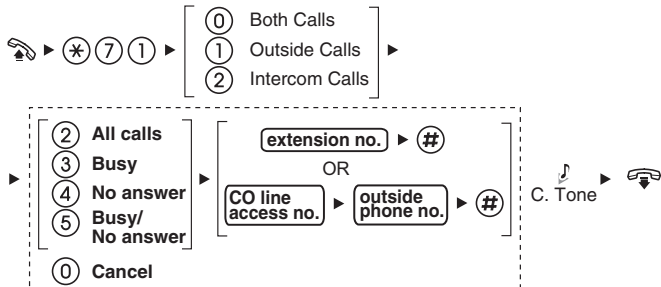

## Making Use of the Voice Mail Service

### Listening to a message

#### From your own extension

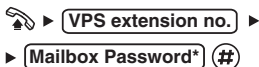

\* If you have no password, you can skip the last step.

#### From someone else's extension

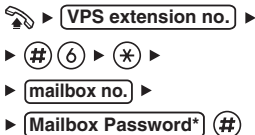

\* If you have no password, you can skip the last step.

#### KX-TVA series

- ① Listen to Message
- ② Deliver Message
- ③ Mailbox Management
- ▶ ④ Automated Attendant
- ⑤ Message Notification
- ⑥ Other Features
- ⊛ End Call

#### KX-TVS series

- ① Listen to Message
- ② Deliver Message
- ③ Check Mailbox Distribution
- ▶ ④ Automated Attendant
- ⑤ Mailbox Management
- ⑥ Other Features
- ⊛ End Call



## Leaving a message

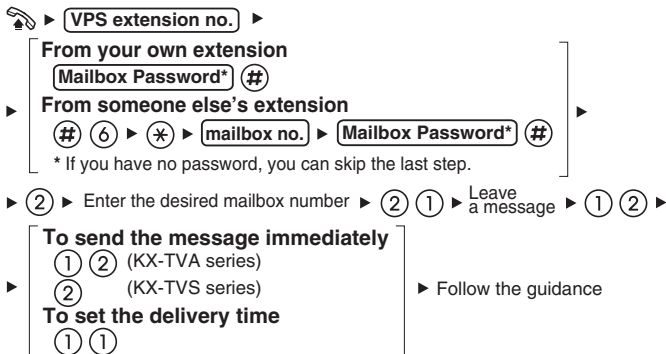

## During playback

- ① Repeat Voice Guidance
- \* Exit

- Consult your dealer or the network administrator for more details regarding feature numbers.
- It is possible to assign flexible CO buttons as feature buttons.
- Control panel/button names and descriptions can be found in "Location of Controls" on page 2.

# Connection

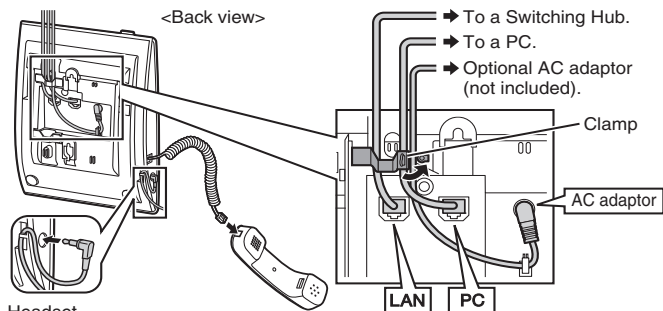

## Headset

Recommended: KX-TCA86, KX-TCA92

Do not use a KX-T7090 headset.

- For extra orders for the accessories, call toll-free: 1-800-332-5368

## PC connection

- Use a straight CAT 5 (or higher) Ethernet cable (not included) that is 6.5 mm (1/4 in) in diameter or less.
- For further information on the connection to a PC, refer to the documentation provided for the PBX.

## Switching Hub connection

- Use a straight CAT 5 (or higher) Ethernet cable (not included) that is 6.5 mm (1/4 in) in diameter or less.

## AC adaptor

- Use a Panasonic AC adaptor KX-A239 (PQLV206).
- The AC adaptor is used as the main disconnect device. Ensure that the AC outlet is located near the unit and is easily accessible.

## CAUTION:

### When connecting cables

- Ensure that the Ethernet cables and the AC adaptor cord are clamped to prevent damage to the connectors.
- Cables may be routed either upwards or downwards by using the appropriate cable clamp located on the back of the unit.

### When connecting a headset and AC adaptor

- Ensure that the headset cord and the AC adaptor cord are wound around the hook to prevent damage to the connectors.

### Attaching the Stand

Place the catches (1) of the stand into hooks located in the unit. Gently push the stand in the direction indicated until it locks into place. The stand will be mounted in the high position.

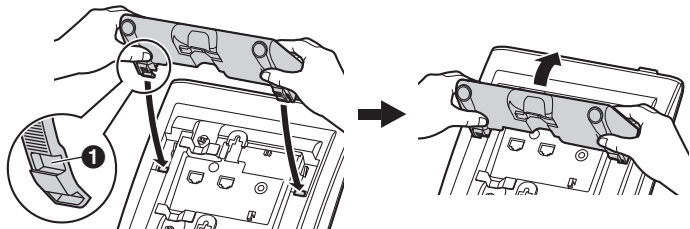

### Removing the Stand

Hold the stand with both hands. Gently rotate the stand in the direction indicated until it is released.

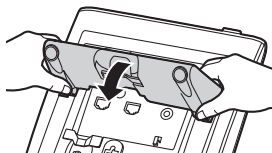

### Cabling

When using the stand, ensure that the cables are clamped as shown.

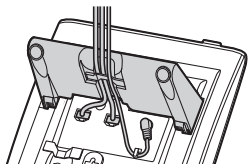

## Stand Usage

---

### Adjusting from High to Low Position

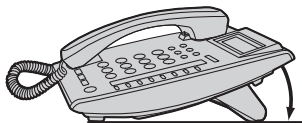

Hold the stand with both hands as shown and gently push the stand in the direction indicated until it locks into the low position (2).

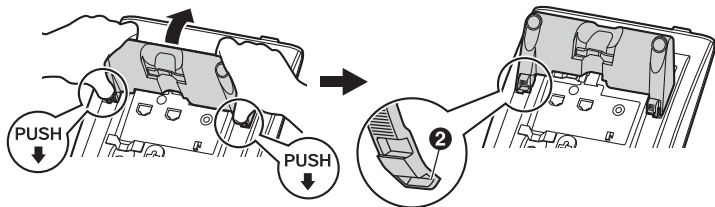

### Adjusting from Low to High Position

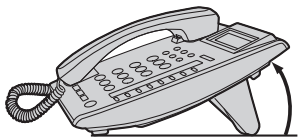

Hold the stand with both hands as shown and gently pull the stand in the direction indicated until it locks into the high position (1).

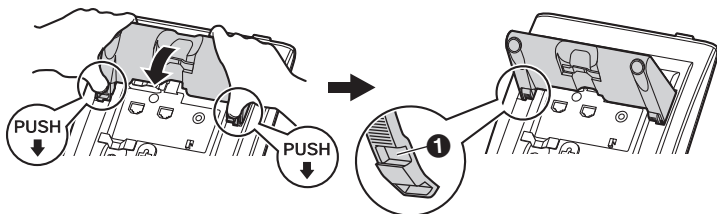

1. Remove the stand if it is attached. For information on removing the stand, refer to page 11.

2. Attach the wall mounting adaptor as shown.

- Make sure the cables are not pinched by the wall mounting adaptor. When running the cables from the top of the unit, look through the opening in the wall mounting adaptor to confirm that the cables are not being pinched.
- Slide the wall mounting adaptor in the direction indicated until it locks into place.

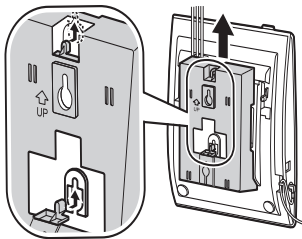

3. Drive the 2 screws into the wall either 83 mm (3-1/4 in) or 100 mm (3-15/16 in) apart, and mount the unit on the wall.

- You can find a wall mounting template on page 19.
- Make sure that the wall that the unit will be attached to is strong enough to support the unit (approx. 1.5 kg [3.31 lb]).
- Make sure the cables are securely fastened to the wall.
- When this unit is no longer in use, make sure to detach it from the wall.

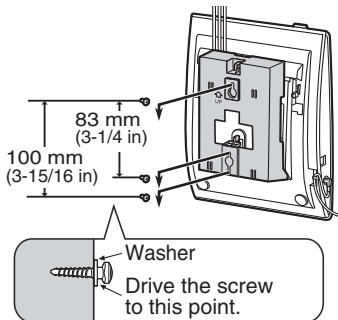

## Locking the Handset Hook

Pull down the handset hook until it locks to prevent the handset from falling off the handset cradle when the unit is mounted to a wall or set at a high angle. To temporarily place the handset down during a conversation, hook it over the top edge of the unit as shown.



## ***Important Information***

---

**When using a KX-NT321 IP-PT, keep the following conditions in mind.**

- If the unit does not operate properly, disconnect the unit from the Ethernet cable and then connect again.
- If you are having problems making calls, disconnect the Ethernet cable and connect a known working IP-PT. If the known working IP-PT operates properly, have the defective IP-PT repaired by an authorized Panasonic factory service center. If the known working IP-PT does not operate properly, check the PBX and the Ethernet cable.
- Wipe the unit with a soft cloth. Do not clean the unit with abrasive powders or with chemical agents such as benzene or thinner.
- Use only the correct Panasonic handset.
- Do not disassemble this unit. Dangerous electrical shock could result. The unit must only be disassembled and repaired by qualified service technicians.
- If damage to the unit exposes any internal parts, immediately disconnect the cable or cord. If the power is supplied from the network to the IP-PT [Power-over-Ethernet], disconnect the Ethernet cable. Otherwise, disconnect the AC adaptor cord. Then return this unit to a service center.
- Never attempt to insert wires, pins, etc. into the vents or other holes of this unit.

**Take special care to follow the safety suggestions listed below.**

### **Safety**

- 1) The unit should only be connected to a power supply of the type described in the Quick Reference Guide or as shown on the label on the unit.
- 2) When left unused for a long period of time, the optional AC adaptor should be unplugged from the AC outlet, if you are using Power-over-Ethernet, disconnect the Ethernet cable.

### **Installation**

#### **Environment**

- 1) Do not use this unit near water, for example, near a bathtub, washbowl or sink. Damp basements should also be avoided.
- 2) Keep the unit away from heating appliances and devices that generate electrical noise, such as fluorescent lamps, motors and televisions. These noise sources can interfere with the performance of the unit. It also should not be placed in rooms where the temperature is less than 5 °C (41 °F) or greater than 40 °C (104 °F). Allow 10 cm (3-15/16 in) clearance around the unit for proper ventilation.

### **Placement**

- 1) Do not place heavy objects on top of this unit.
- 2) Care should be taken so that objects do not fall onto, and liquids are not spilled into, the unit. Do not subject this unit to excessive smoke, dust, moisture, mechanical vibration, shock or direct sunlight.
- 3) Place the unit on a flat surface.

### **WARNING:**

TO PREVENT POSSIBLE FIRE OR ELECTRIC SHOCK, DO NOT EXPOSE THIS UNIT TO RAIN OR MOISTURE.

THIS HANDSET EARPIECE IS MAGNETIZED AND MAY RETAIN SMALL FERROUS OBJECTS.

DISCONNECT THIS UNIT FROM POWER OUTLET/THE ETHERNET CABLE IF IT EMITS SMOKE, AN ABNORMAL SMELL OR MAKES UNUSUAL NOISE. THESE CONDITIONS CAN CAUSE FIRE OR ELECTRIC SHOCK. CONFIRM THAT SMOKE HAS STOPPED AND CONTACT AN AUTHORIZED SERVICE CENTER.

### **IMPORTANT NOTICE:**

- Under power failure conditions, the IP-PT may not operate. Please ensure that a separate telephone, not dependent on local power, is available for use in remote sites in case of emergency.
- For information regarding network setup of the IP-PT such as IP addresses, please refer to the Installation Manual for the Panasonic PBX.
- If an error message is shown on your display, consult your dealer or the network administrator.
- The firmware of the KX-NT321 is protected by copyright laws and international treaty provisions, and all other applicable laws. It cannot be reverse engineered, decompiled or disassembled.

### **When you ship the product:**

Carefully pack and send it prepaid, adequately insured and preferably in the original carton. Attach a postage-paid letter, detailing the symptom to the outside of the carton.

DO NOT send the product to the Executive or Regional Sales offices. They are NOT equipped to make repairs.

### **Product service:**

Panasonic factory service centers for this product are listed in the service center directory.

Consult your authorized Panasonic dealer for detailed instructions.

## ***Important Information***

---

### **Important Safety Instructions**

When using this unit, basic safety precautions, including those below, should always be followed to reduce the risk of fire, electric shock and injury to persons.

1. Read and understand all instructions.
2. Follow all warnings and instructions marked on this unit.
3. Unplug this unit from the AC outlet before cleaning. Do not use liquid or aerosol cleaners. Clean with a damp cloth.
4. Do not use the unit near water, for example, near a bathtub, kitchen sink, or laundry tub, in a wet basement, or near a swimming pool.
5. Place this unit on a flat surface. Serious damage and/or injury may result if the unit falls.
6. The unit should never be placed near or over a radiator or other heat source.
7. This unit should be operated only from the type of power source indicated on the unit label. If you are not sure of the type of power supply to your home, consult your dealer or local power company.
8. Do not allow anything to rest on the power cord. Do not locate this unit where the cord may be stepped on or tripped on.
9. To reduce the risk of fire or electric shock, do not overload AC outlets and extension cords.
10. Do not insert objects of any kind into this unit through openings, as they may touch dangerous voltage points or short out parts that could result in a risk of fire or electric shock. Never spill liquid of any kind on the unit.
11. To reduce the risk of electric shock, do not disassemble this unit. Only qualified personnel should service this unit. Opening or removing covers may expose you to dangerous voltages or other risks. Incorrect reassembly can cause electric shock.
12. Unplug this unit from the AC outlet and have the unit serviced by qualified service personnel in the following cases:
  - A. When the power supply cord or plug is damaged or frayed.
  - B. If liquid has been spilled on the unit.
  - C. If the unit has been exposed to rain or water.
  - D. If the unit does not work normally by following the manual. Adjust only controls covered by the manual. Improper adjustment may require repair by an authorized service center.
  - E. If the unit has been dropped, or damaged.
  - F. If the unit's performance deteriorates.
13. Avoid using a telephone (other than a cordless type) during an electrical storm. There is a remote risk of electric shock from lightning.
14. Do not use the telephone in the vicinity of a gas leak to report the leak.

**SAVE THESE INSTRUCTIONS**



## **FCC Information**

### **F.C.C. REQUIREMENTS AND RELEVANT INFORMATION**

This equipment has been tested and found to comply with the limits for a Class B digital device, pursuant to Part 15 of the FCC Rules. These limits are designed to provide reasonable protection against harmful interference in a residential installation.

This equipment generates, uses, and can radiate radio frequency energy and, if not installed and used in accordance with the instructions, may cause harmful interference to radio communications. However, there is no guarantee that interference will not occur in a particular installation. If this equipment does cause harmful interference to radio or television reception, which can be determined by turning the equipment off and on, the user is encouraged to try to correct the interference by one or more of the following measures:

- Reorient or relocate the receiving antenna.
- Increase the separation between the equipment and receiver.
- Connect the equipment into an outlet on a circuit different from that to which the receiver is connected.
- Consult the dealer or an experienced radio/TV technician for help.

### **CAUTION:**

To assure continued compliance with FCC rules, do not make any unauthorized changes or modifications to this equipment would void the user's authority to operate this device.

When programming emergency numbers and/or making test calls to emergency numbers:

- 1) Remain on the line and briefly explain to the dispatcher the reason for the call before hanging up.
- 2) Perform such activities in the off peak hours, such as early morning hours or late evenings.

### **FCC Declaration of Conformity**

Trade Name: Panasonic

Model Number: KX-NT321

Responsible Party: Panasonic Corporation of North America

One Panasonic Way

Secaucus, NJ 07094 U.S.A.

Telephone No.: 1-800-211-PANA (7262)

This device complies with Part 15 of the FCC Rules.

Operation is subject to the following two conditions: (1) This device may not cause harmful interference, and (2) this device must accept any interference received, including interference that may cause undesired operation.

## ***Important Information***

---

### **Customer Information**

This equipment complies with Part 68 of the FCC rules and the requirements adopted by the ACTA. On the bottom of the cabinet of this equipment is a label that contains, among other information, the following product identifier:  
*US: ACJKXNANKX-NT321*

If requested, this number must be provided to the telephone company.

If trouble is experienced with this equipment KX-NT321, for repair or warranty information, please contact:

Panasonic Service and Technology Company-BTS Center  
415 Horizon Drive Bldg. 300 Ste. 350-B  
Suwanee, GA 30024-3186

If the equipment is causing harm to the telephone network, the telephone company may request that you disconnect the equipment until the problem is resolved.

### **Hearing Aid Compatibility:**

This telephone provides magnetic coupling for hearing aids.

# Wall Mounting Template

## WALL MOUNTING TEMPLATE

1. Drive the screws into the wall as indicated.
2. Hook the unit onto the screw heads.

### **Note:**

Make sure to set the print size to correspond with the size of this page. If the dimensions of the paper output still deviate slightly from the measurements indicated here, use the measurements indicated here.

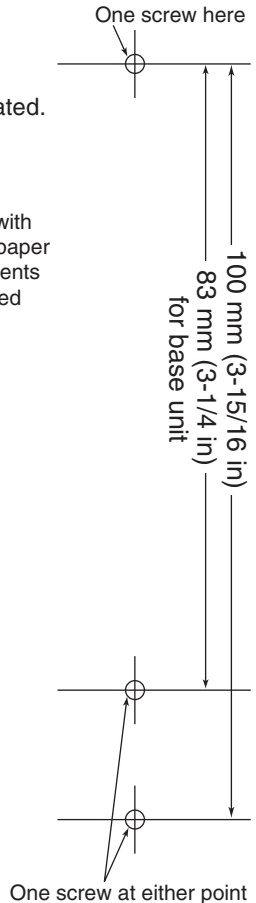

**Panasonic Consumer Electronics Company,  
Division of Panasonic Corporation of North America**

One Panasonic Way Secaucus, New Jersey 07094

**Panasonic Puerto Rico, Inc.**

San Gabriel Industrial Park Ave. 65 de Infantería, Km. 9.5  
Carolina, Puerto Rico 00985

<http://www.panasonic.com/csd>

**Copyright:**

This material is copyrighted by Panasonic Communications Co., Ltd., and may be reproduced for internal use only. All other reproduction, in whole or in part, is prohibited without the written consent of Panasonic Communications Co., Ltd.

© 2008 Panasonic Communications Co., Ltd. All Rights Reserved.